

# ARMÁRIO AÉREO 02 PORTAS BÁSCULAS NESHER BARONESA 80 CM 100% MDF

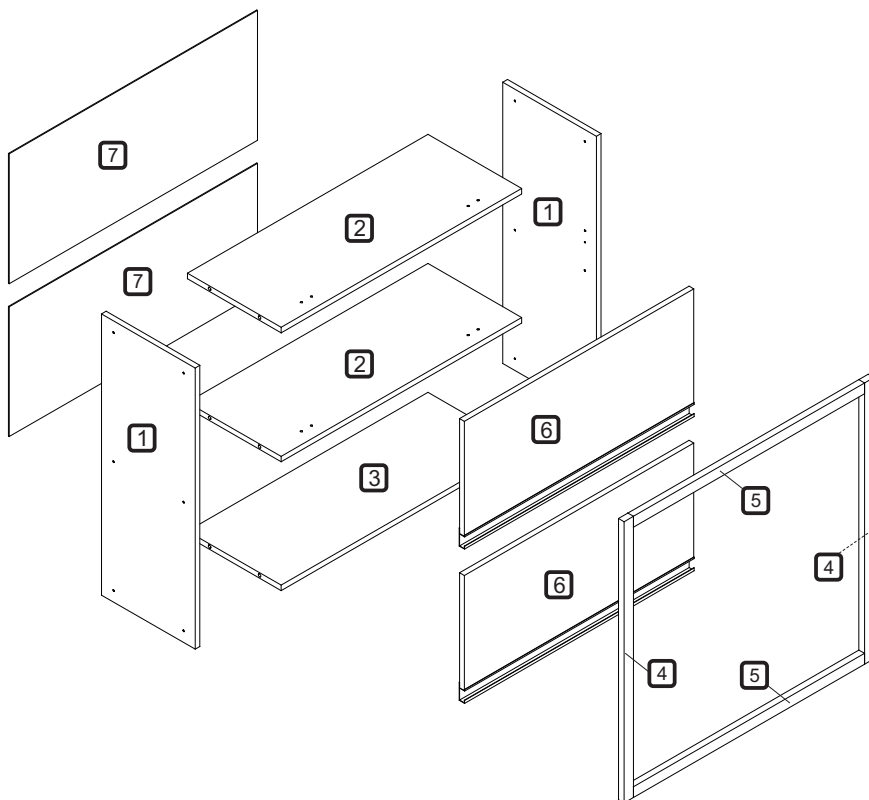

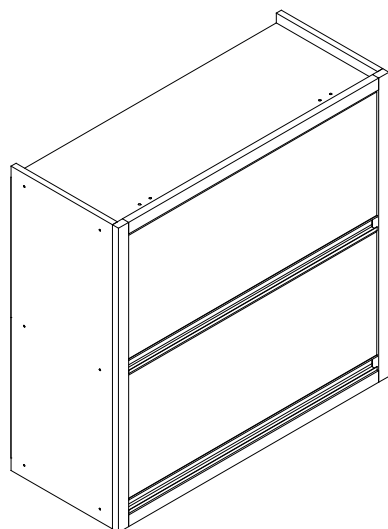

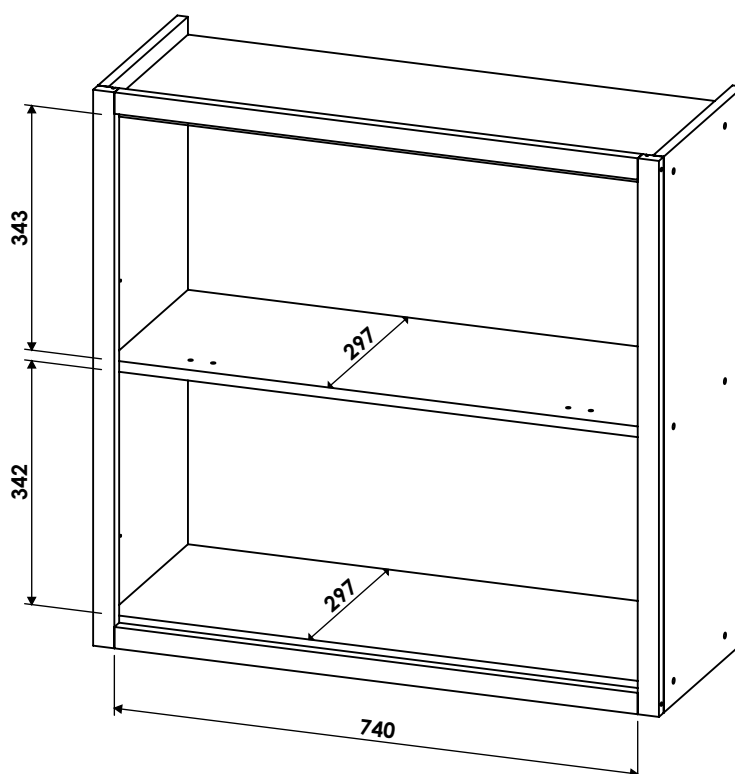

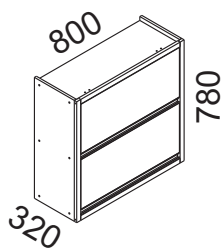

## DIMENSÕES DOS ESPAÇOS INTERNOS (MEDIDAS EM MILÍMETRO)

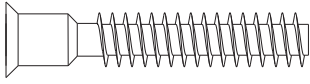
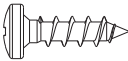
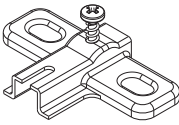
DIMENSÕES MÁXIMAS DO PRODUTO MONTADO

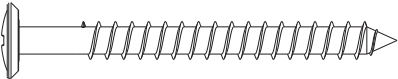
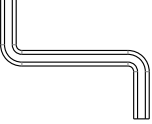
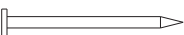
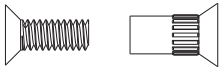
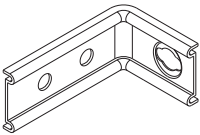
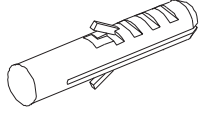
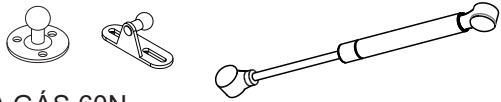
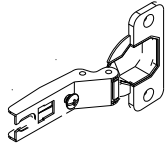

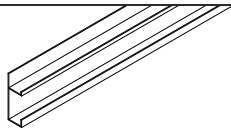
CÓDIGO	DESCRIÇÃO	QTDE	COMP.	LARG.	ESP.
1	LATERAL	2	780	297	15
2	TAMPO / PRATELEIRA	2	770	297	15
3	BASE	1	770	297	15
4	MOLDURA LATERAL	2	780	30	18
5	MOLDURA SUPERIOR INFERIOR	2	740	30	18
6	PORTA BASCULANTE	2	734	322	15
7	FUNDO TRASEIRO	2	795	363	2,5

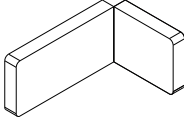
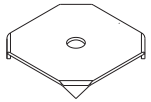
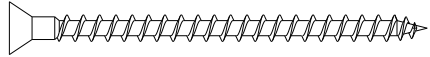
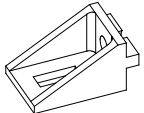
CÓDIGO/DESCRIÇÃO	QUANTIDADE	CÓDIGO/DESCRIÇÃO	QUANTIDADE
<b>A</b>  PARAFUSO 7x40mm CABEÇA CHATA	12	<b>B</b>  PARAFUSO 4x14mm CABEÇA PANELA	50
<b>C</b>  CALÇO PARA DOBRADIÇA 35mm	4	<b>D</b>  PARAFUSO UNIAO DE MÓDULOS 28MM	3
<b>E</b>  PARAFUSO 5x50mm CABEÇA FLANGEADA	4	<b>F</b>  CHAVE ZETA	1
<b>G</b>  PREGO 10x10 COM CABEÇA	34	<b>H</b>  PARAFUSO DE UNIÃO 17mm	8
<b>I</b>  CANTONEIRA METALICA PARA FIXAÇÃO NA PAREDE	4	<b>J</b>  BUCHA DE PAREDE DE 8mm	4
<b>K</b>  PISTÃO A GÁS 60N	2	<b>L</b>  DOBRADIÇA ALTA CANECO 35mm	4
<b>M</b>  BATENTE DE SILICONE	4	<b>N</b>  PUXADOR J 733MM	2
<b>O</b>  TAPA FURO ADESIVO 12mm	16	<b>P</b>  CAPA PLÁSTICA PARA CANTONEIRA	4
<b>Q</b>  FIXADOR FUNDO TRASEIRO METÁLICO	8	<b>R</b>  PARAFUSO 3,5X50mm CABEÇA CHATA	4
<b>S</b>  SUPORTE ANGULAR	12		